



Producer: **Danfoss**

Line: **MTZ**

Model: **MTZ160-4**

Cooling capacity [kW]: **20.31**

Displacement [m³/h]: **47.2**

Refrigerant: **R134a, R404A, R407A, R407C, R407F, R448A, R449A, R452A, R513A**

Capacity control: **None**

Power supply: **400V/3Ph/50Hz**

Data

Technical data

Displacement	[m ³ /h]	47.2
Swept volume	[cm ³]	271.55
Cylinders quantity		4
Oil charge	[l]	3.90
Oil type		175PZ
Internal free volume (suction)	[dm ³]	31.0
Internal free volume (discharge)	[dm ³]	1.2
Net weight	[kg]	65.00
Gross weight	[kg]	70.25

Electrical data

Power supply		400V/3Ph/50Hz
Maximum continuous current	[A]	36.0
Locked rotor amperage	[A]	130.0
Revolutions per minute	[RPM]	2900
Motor resistance main	[Ω]	1.15

Limits

Maximum suction pressure	[bar]	22.6
Maximum discharge pressure	[bar]	29.4
Maximum suction temperature	[°C]	50.0
Minimum suction temperature	[°C]	-35.0
Maximum discharge temperature	[°C]	150.0
Minimal discharge temperature	[°C]	-35.0

Dimensions

Suction valve diameter	[inch]	1 1/8
Discharge valve diameter	[inch]	3/4
Suction connection thread diameter	[inch]	1 3/4
Discharge connection thread diameter	[inch]	1 1/4
Diameter	[mm]	352
Height	[mm]	540
Oil equalization		3/8" Flare SAE

Other

Product codes	MTZ160-4VI, MTZ160-4VM
Approved refrigerants	R134a, R404A, R407A, R407C, R407F, R448A, R449A, R452A, R513A
Capacity control	None
Protection rating ¹	IP54
Glass mounting	Threaded

Shipped equipment

Motor protection	Internal overload protector
Shipped fittings	Suction and discharge solder sleeves, rotolock nuts and gaskets
Shipped mounting	Mounting kit with grommets, bolts, nuts, sleeves and washers

¹ With cable gland.

Performance

Nominal conditions: refrigerant: R404A, evaporation: -10°C (dew point), condensation: 45°C (dew point), superheating: 10K, subcooling: 0°C

Cooling capacity

		Evaporation temperature [°C]								
		-30	-25	-20	-15	-10	-5	0	5	10
Condensation temperature [°C]	30	9.61	12.95	17.01	21.90	27.70	34.52	42.43	51.55	61.95
	35	8.45	11.55	15.32	19.85	25.23	31.56	38.93	47.44	57.18
	40	7.34	10.19	13.65	17.81	22.76	28.60	35.42	43.31	52.37
	45	6.28	8.87	12.01	15.79	20.31	25.64	31.90	39.16	47.54
	50	5.25	7.58	10.40	13.79	17.85	22.68	28.36	34.99	42.66
	55		6.33	8.80	11.79	15.39	19.70	24.79	30.78	37.75
	60		5.09	7.22	9.81	12.93	16.71	21.21	26.54	32.79



Power consumption

		Evaporation temperature [°C]								
		-30	-25	-20	-15	-10	-5	0	5	10
Condensation temperature [°C]	30	6.68	7.51	8.28	9.00	9.68	10.32	10.96	11.58	12.22
	35	6.77	7.71	8.58	9.40	10.19	10.94	11.68	12.42	13.17
	40	6.81	7.85	8.83	9.76	10.65	11.51	12.36	13.21	14.07
	45	6.80	7.95	9.04	10.08	11.08	12.05	13.01	13.98	14.95
	50	6.76	8.02	9.21	10.36	11.48	12.56	13.64	14.72	15.81
	55		8.06	9.37	10.63	11.86	13.06	14.25	15.45	16.66
	60		8.08	9.51	10.88	12.23	13.55	14.86	16.18	17.50

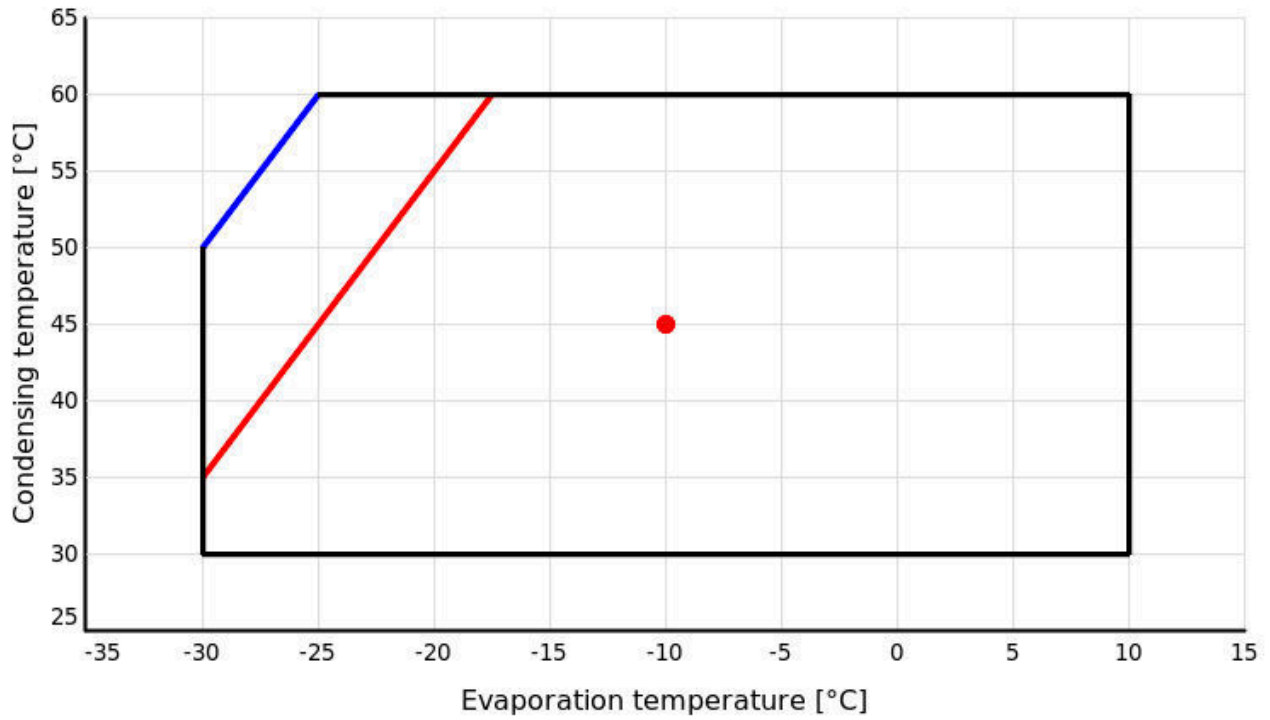
Application range



Legend

-  Suction gas superheating: 11 K
-  Suction gas superheating: 30 K

Dimensions

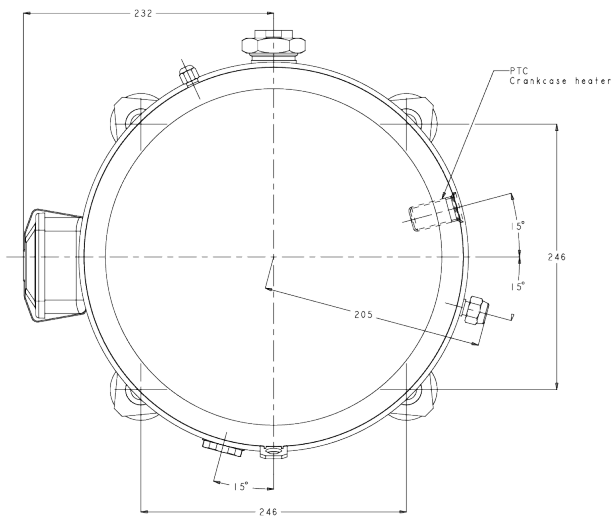
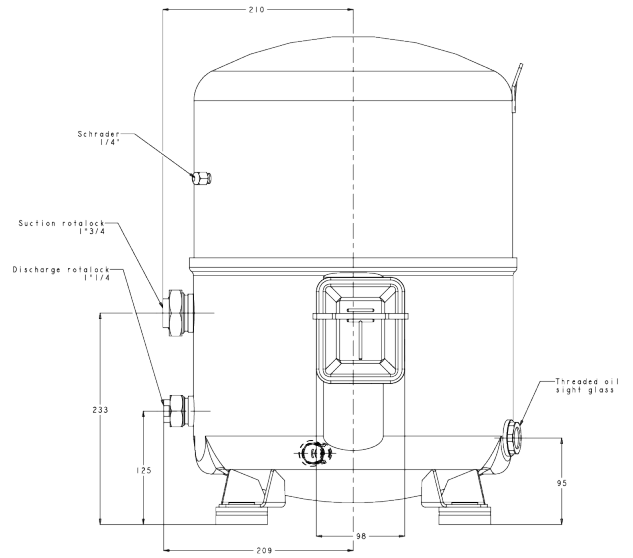
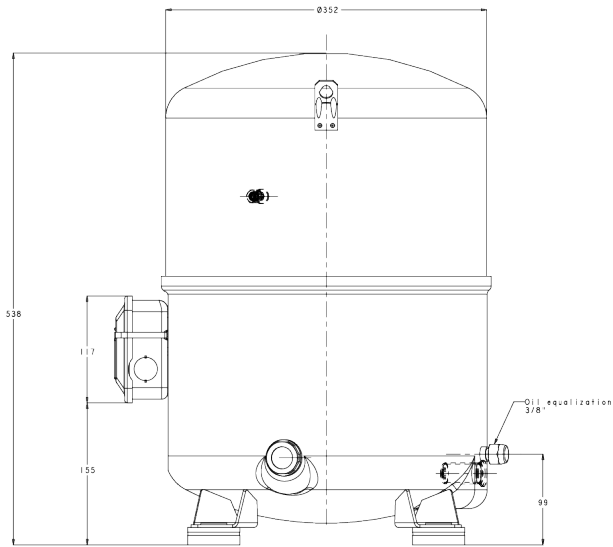

Silent bloc

Grommet compression not included around 1 mm.

